

# PUERTAS PLEGADIZAS

## Pieghevole para una 1 puerta de 2 hojas



Código: 0209-003

Material: Plástico y  
acero

Capacidad de carga: 50kg por  
puerta

Herraje complementario: 0209-002 / 0209-003  
Bisagra bidimensional 110°

Unidad de medida: Juego

### Diagrama de ensamble

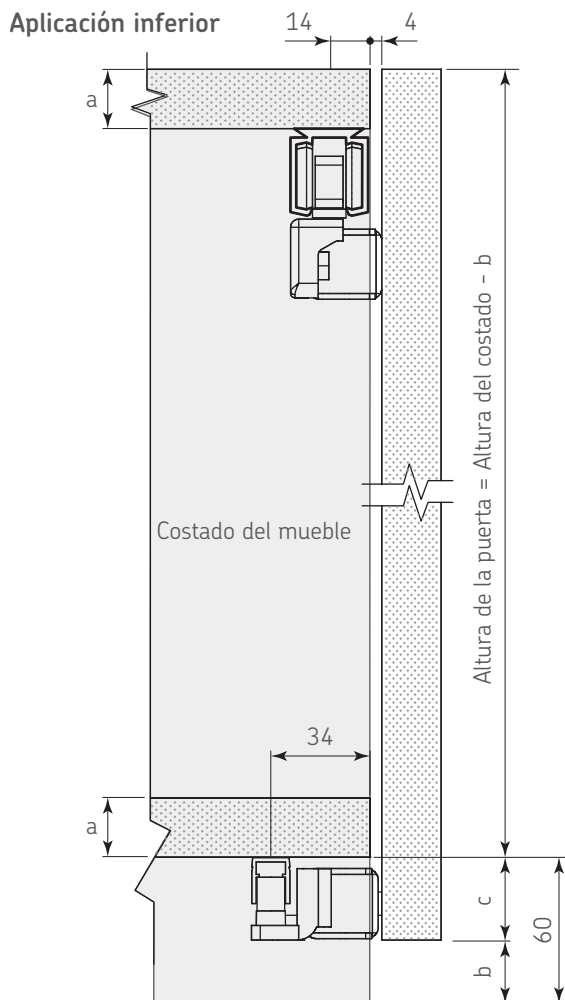

#### Notas Generales

- a Espesor de panel
- b 60 - c
- c Min. 25

### Diagrama de producto

#### Carretilla superior

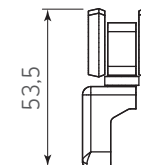
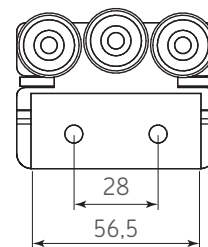
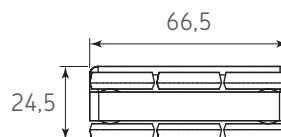

#### Carretilla inferior

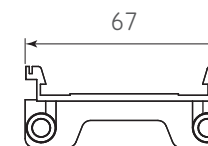

#### Bisagra superior / inferior

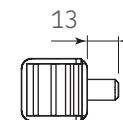
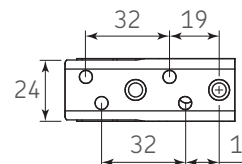
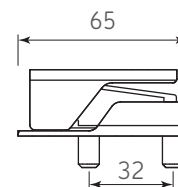

#### Bisagra central

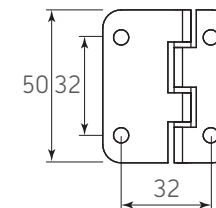
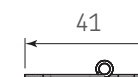

#### Seguro

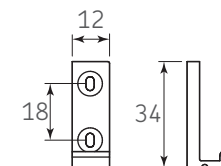

**NOTA:** La medida "c" esta sujeta a consideración del cliente, pero se recomienda como mínimo 25mm

Dimensiones expresadas en: mm

(Medidas de referencia para su instalación. Se puede generar cambios a la información publicada en este documento sin previo aviso)

FT-0209-003 Rev. 1

# PUERTAS PLEGADIZAS

Pieghevole para una 1 puerta de 2 hojas



## Diagrama de ensamble:

### Perforación de la puerta

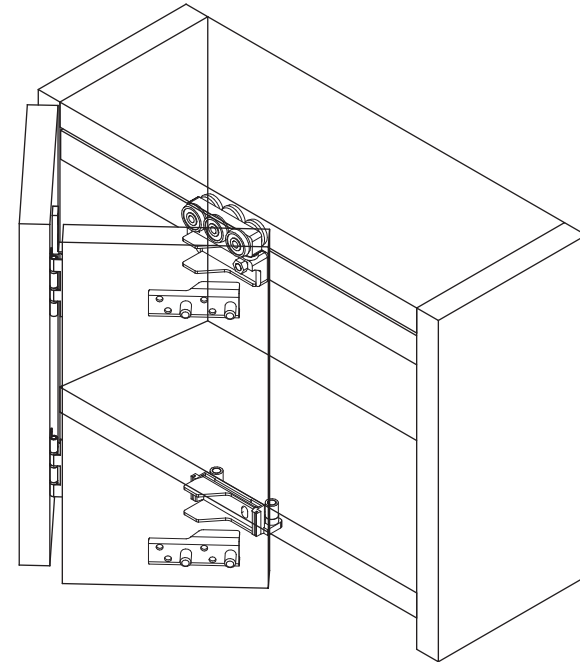
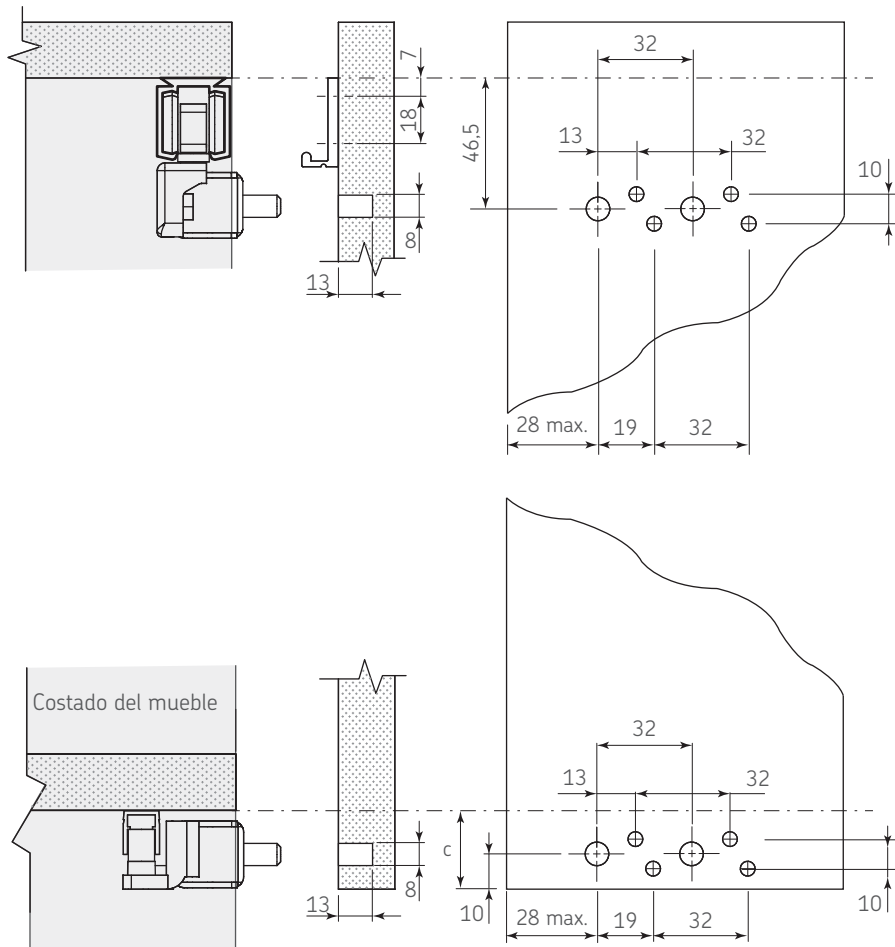

### Componentes del sistema

Descripción	Cantidad	Descripción	Cantidad
 Carretilla superior	1	 Bisagra central	3
 Carretilla inferior	1	 Seguro	1
 Bisagra superior / inferior	2		

**NOTA:** La medida "c" esta sujeta a consideración del cliente, pero se recomienda como mínimo 25mm

Dimensiones expresadas en: mm (Medidas de referencia para su instalación. Se puede generar cambios a la información publicada en este documento sin previo aviso)

FT-0209-003 Rev. 1